

**D** Bedienungsanleitung

**GB** Operation Instructions

## • AE2105 •

### Clinchhöhenmessgerät Gauge for the determination of the clinch height

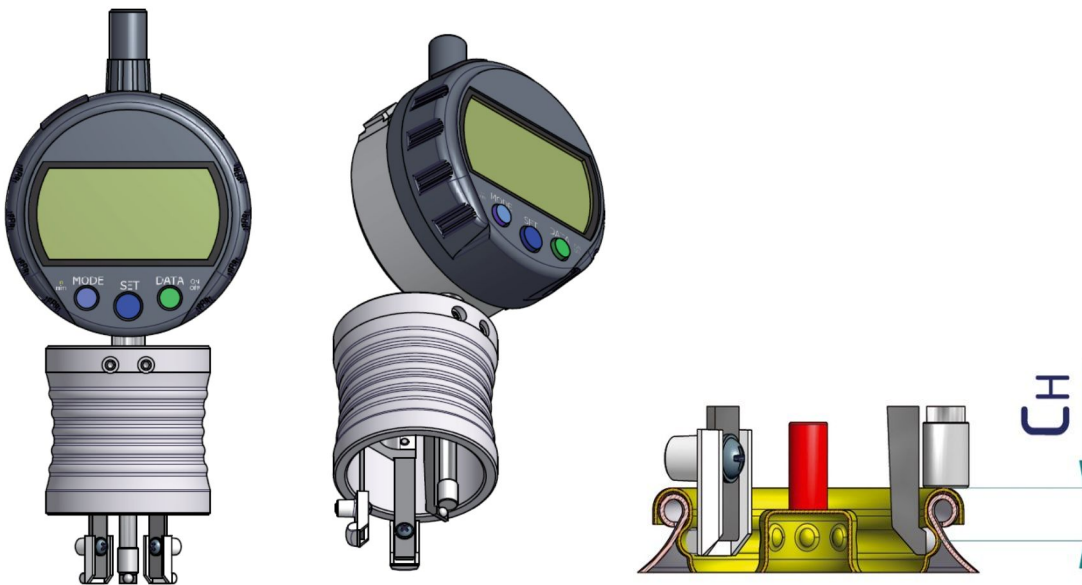

Technische Änderungen vorbehalten.

Soweit durch diese Anweisung Vorschriften im Schadensfall aus dem Produkthaftungsgesetz berührt sind, werden diese hiermit ausdrücklich ausgeschlossen.

Subject to technical alterations.

If because of this instruction, rules in the Product Liability Act are referred to in case of damage these will herewith be explicitly excluded.

**Bitte vor jeder Messung beachten!**

1. Nicht in Räumen mit hoher Luftfeuchtigkeit verwenden.
2. Kalibrierung der Meßuhr überprüfen.

**Please note the following before each measurement!**

1. Do not use the dial indicator in high air humidity
2. Check the calibration of the dial indicator.

### Allgemeine Hinweise:

Vor dem Messen mit dem Clinchhöhenmessgerät AE2105 ist die Anzeige (Maß 1.25mm) zu überprüfen.

Liegt der Messkontakt auf der Kugel auf, soll das Gerät das Maß 1,25mm anzeigen.

-Kalibrierung ohne Kalibrierring:

Der PRESET-Wert der Meßuhr wird auf den Kugelradius  $R=1.25\text{mm}$  eingestellt.

-Kalibrierung mit Kalibrierring **0641-32**:

Der PRESET-Wert wird auf das Kalibriermaß, welches auf dem Ring eingätzt ist, eingestellt.

### Generalities

Before measuring with the gauge AE2105, check the display (measure 1.25 mm). When the measuring contact is put on the ball, the gauge should indicate a value of 1,25 mm.

- Calibration without ring gauge:

Adjust the PRESET value of the dial indicator to the spherical diameter  $R = 1,25 \text{ mm}$ .





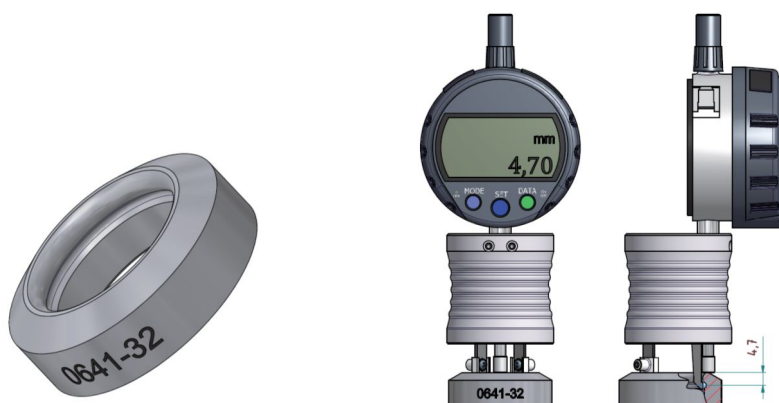















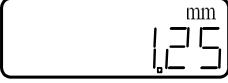

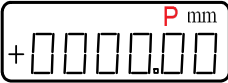



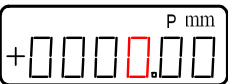





- Calibration with ring gauge **0641-32**:

Adjust the PRESET value to the calibration value engraved on the ring gauge.

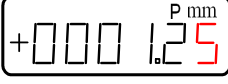

























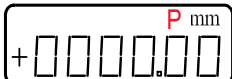

**Kalibrierring 0641-32 / ring gauge 0641-32**

**Einstellung des PRESET-Wertes**

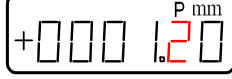
Bedienung / Tastenbetätigung	Symbol / Taste	Anzeige
<b>Art der Tastaenbetätigung:</b> – Drücken und loslassen (max. 2s)	  	
– Drücken und gedrückt halten (min. 2s)	  	
<b>Einschalten</b>	 ON/ OFF	
<b>Aktivieren des voreingestellten PRESET-Wertes (1.25mm)</b> - PRESET-Wert zur Anzeige bringen - PRESET-Wert übernehmen	 SET   SET	 
<b>Neueinstellung eines PRESET-Wertes (Beispiel: 0.00mm auf 1.25mm)</b> – PRESET-Wert zur Anzeige bringen	 SET	
<b>Dezimalstelle anwählen</b> -SET-Taste loslassen, sobald das „+“ Symbol blinkt -Durch erneutes drücken der SET-Taste die gewünschte Position auswählen (im Bsp. 4 mal Drücken um auf die vierte Stelle von links zu kommen)	 SET   4 x SET	 
– Zahl „4“ einstellen + zu – 0 1 2..... 9. – nächste Dezimalstelle anwählen	 MODE   SET	 
– Zahl “2” einstellen  – nächste Dezimalstelle anwählen	 MODE   SET	 
– Zahl “5” einstellen	 MODE	
– PRESET-Einstellung abschließen (PRESET-Taste so oft drücken bis „P“ blinkt)	 SET	
– PRESET-Wert übernehmen	 SET	
mm/inch - Umschaltung (vor oder nach der PRESET-Einstellung)	 mm/ inch	

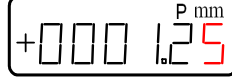
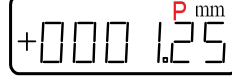
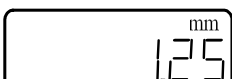
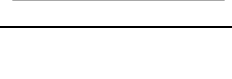
### Setting the preset value

Action / Key	Symbol / Key	Display
<b>Signs and symbols:</b> - Press shortly and release.		
- Press until the display changes.		
- Switch on.	 ON/ OFF	
<b>Activate the PRESET value (1.25mm)</b> - Display the PRESET value - Store the PRESET value	 SET   SET	 
<b>Adjustment of a new PRESET value (Example: from 0.00mm to 1.25mm)</b>  - Display the PRESET value  - the SET button hold until the “+” symbol flashes  - After pressing the SET button to select the desired position (in this example, press 4 times to get to the fourth digit from the left)  - Adjust the digit „4“ + to – 0 → 1 → 2..... → 9.  - Select next decimal  - Adjust the digit „2“  - Select next decimal  - Adjust the digit „5“  -Finish adjustment of the PRESET-value. (Release the PRESET-key as soon as „P” flashes.) - Store the PRESET value	 SET   SET   4 x SET   MODE   SET   MODE   SET   MODE   SET   SET	          
mm/inch - conversion (before or after PRESET adjustment)	 mm/ inch	

**Messvorgang / Measurement**

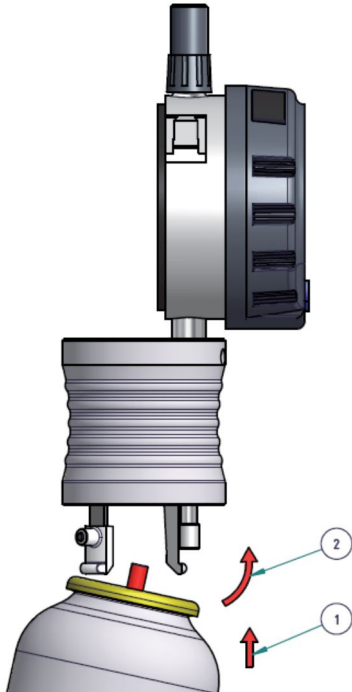

Einsetzen des Gerätes  
Installation of gauge



Messen Clinchhöhe CH  
Measurement Clinch height CH

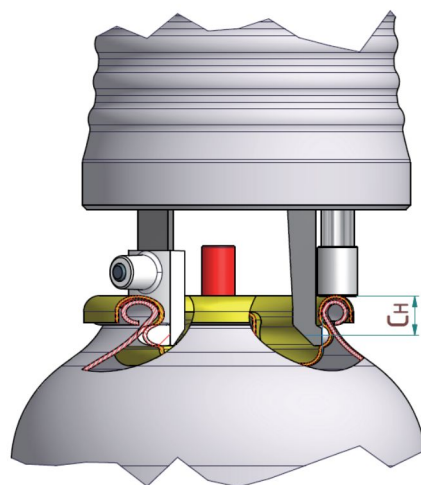

**Ersatzteile / Spare parts**

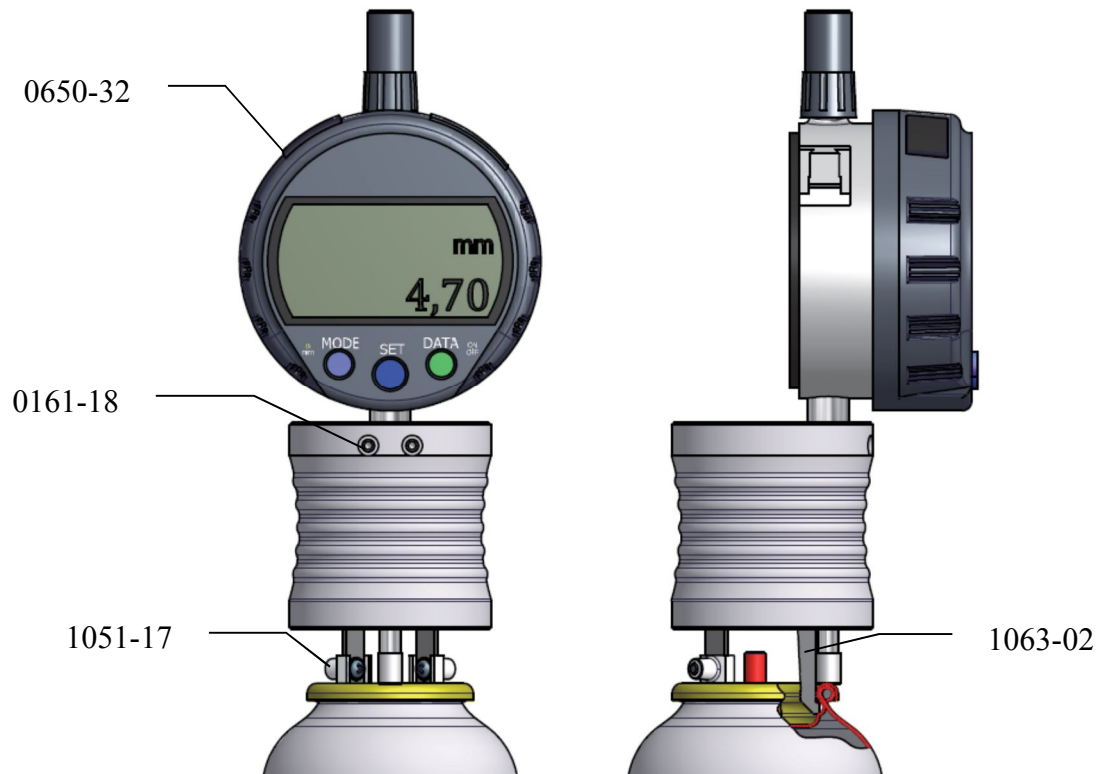

0650-32 Meßuhr  
 1063-02 Tastarm mit Kugel  
 1051-17 Klotz  
 0161-18 Gewindestift M3x5

dial gauge  
 caliper arm with ball  
 stand  
 set screw M3x5

**Notizen / notes**

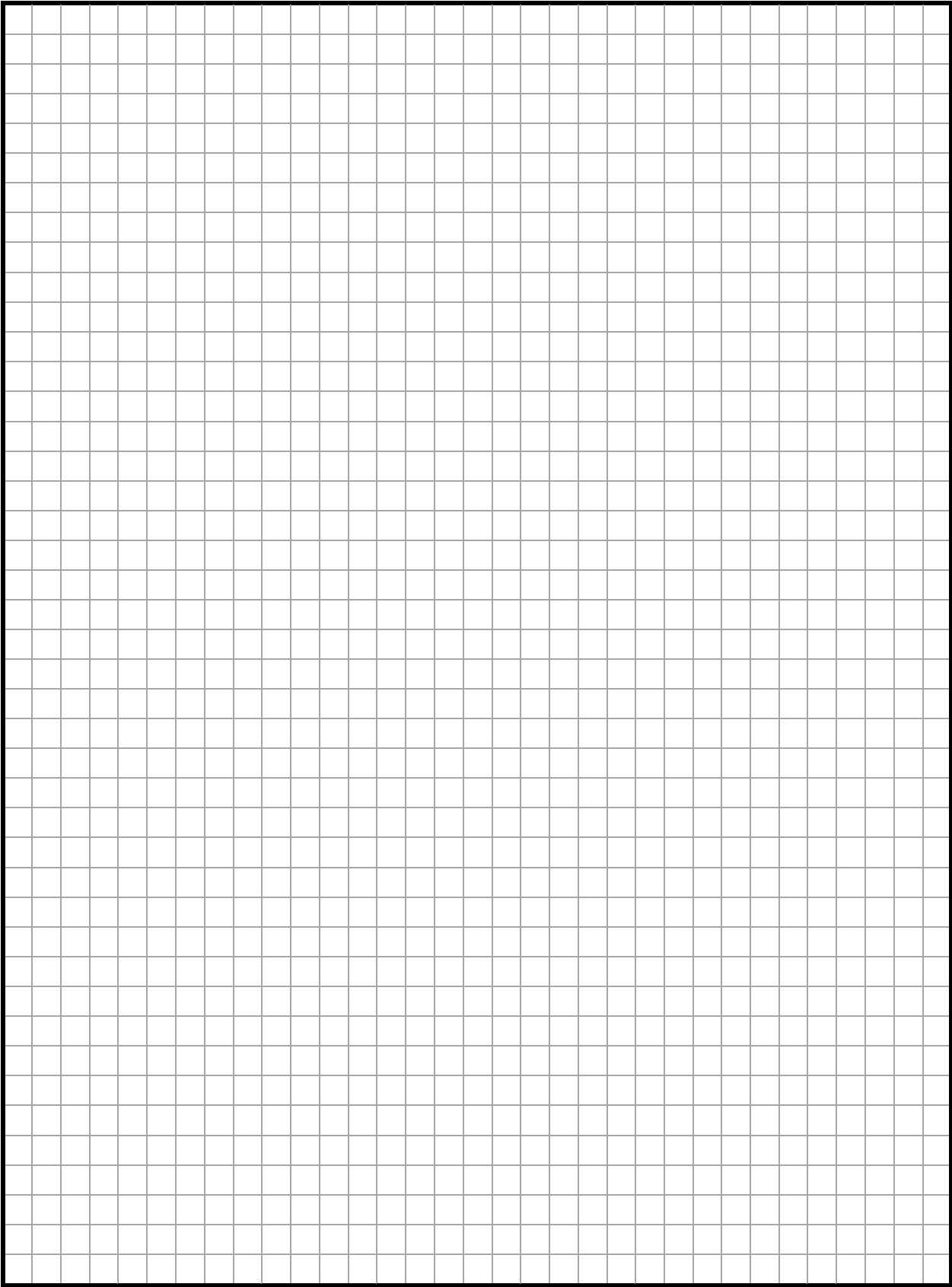

Kroeplin GmbH  
Gartenstraße 50  
D- 36381 Schlüchtern  
Germany

 + 49 (0) 66 61 - 86-0  
Fax: + 49 (0) 66 61 - 86 39

<http://www.kroeplin.com>  
[sales@kroeplin.com](mailto:sales@kroeplin.com)