

data sheet: L2G20

Kroeplin GmbH
Gartenstraße 50
D-36381 Schlüchtern

Tel.: 06661 86 0
Fax: 06661 86 39
Mail: sales@kroeplin.com
Web: www.kroeplin.com

Kroeplin
Längenmesstechnik

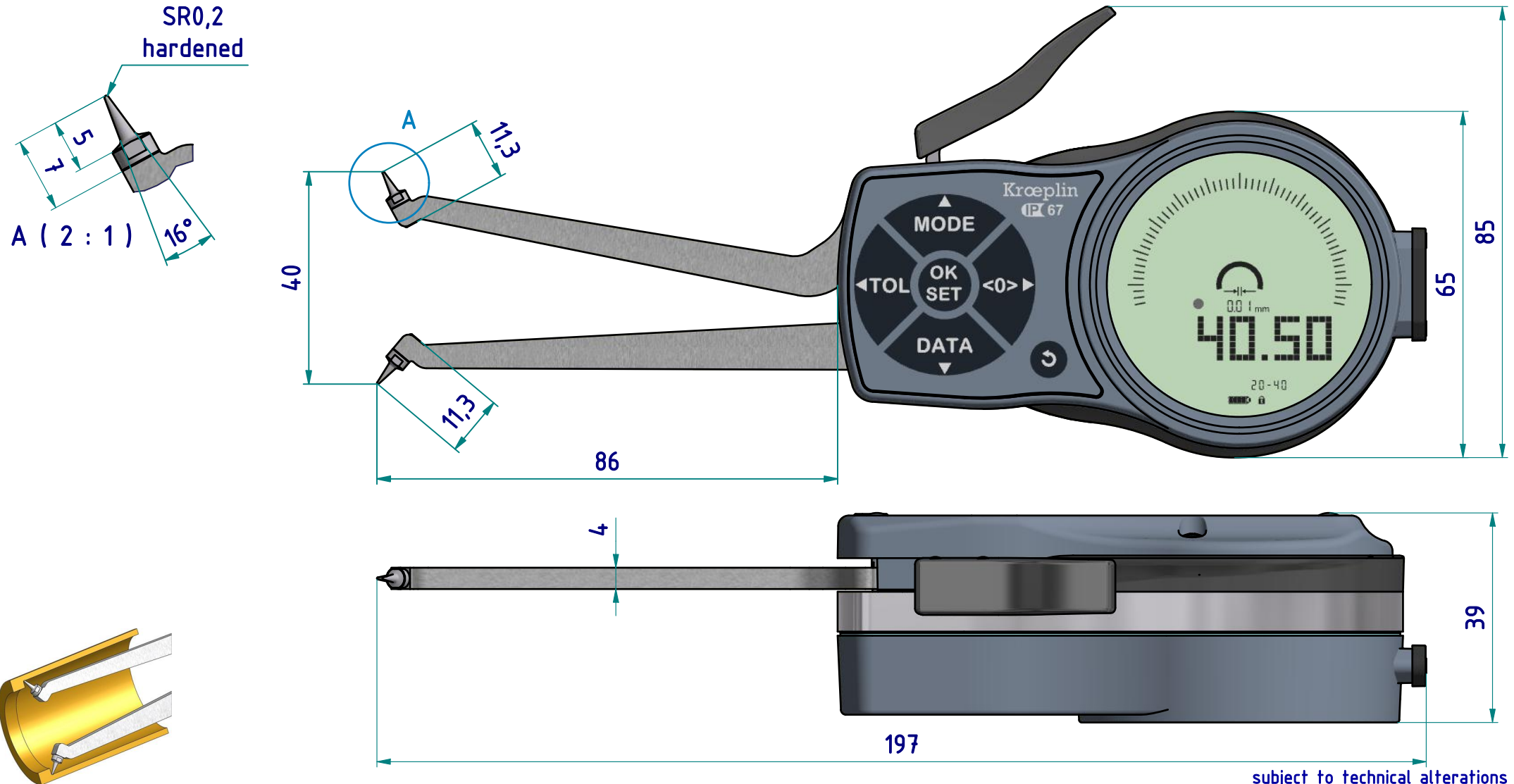

subject to technical alterations

type: L
range: 20 - 40 mm
range of indication: 19,5 - 40,5 mm
digital step: 0,01 mm
scale interval: -
measuring force: 1,1 - 1,6 N
weight: 270 g

acceptable deviations
VDI/VDE/DGQ 2618 Bl. 12.1/13.1)
max. permissible
errors "G": 0,03 mm
repeatability "r": 0,01 mm
reference temperature: 20° C
operation temperature: 10° C - 30° C
storage temperature: -10° C - 50° C

scale: 1:1
drawing-nr.: DAB-L2G20-K-e
date of issue: 12.05.2020
name: B. Schmidt
revision status: 001
revision date: 23.09.2020

interface as accessories available:

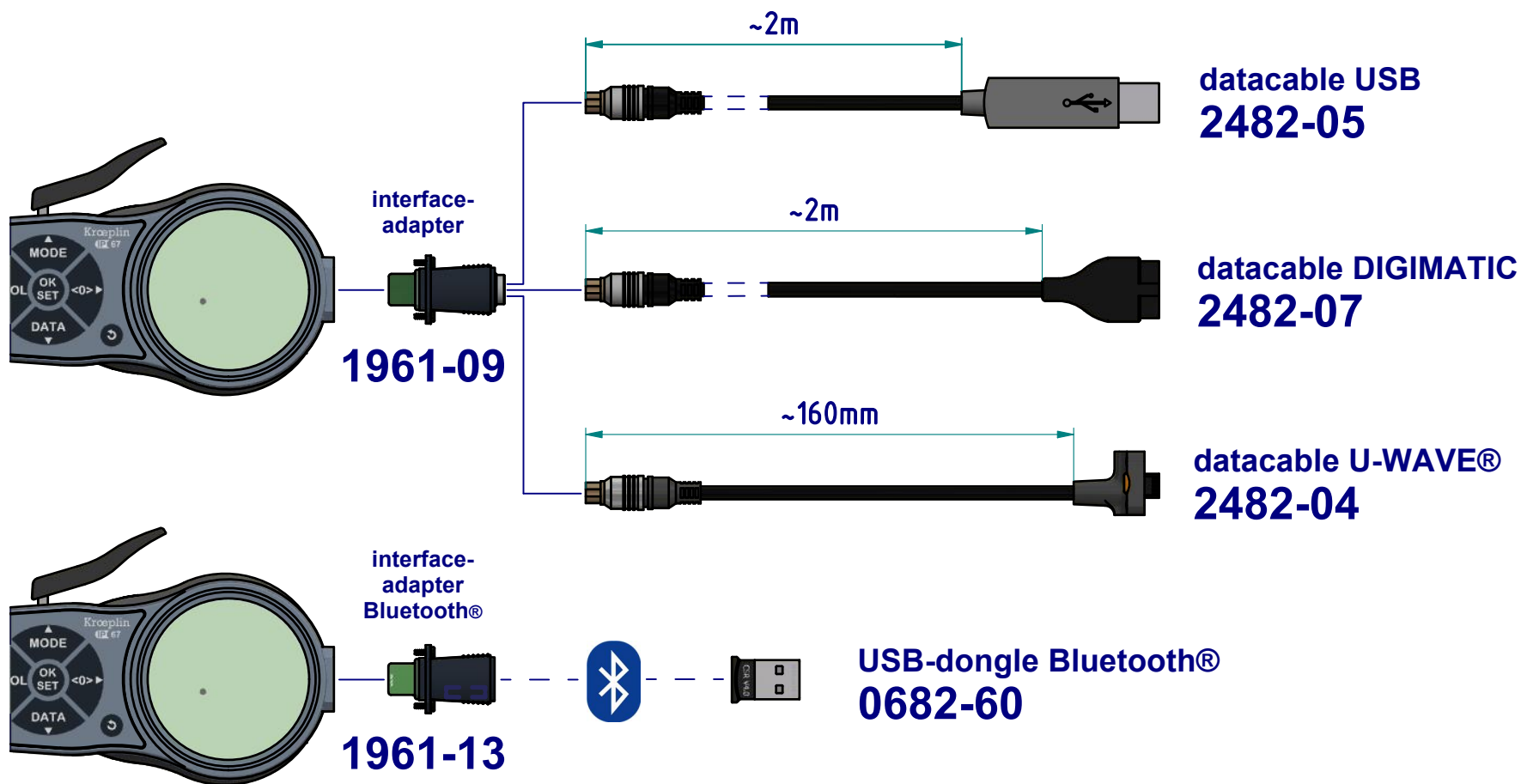

subject to technical alterations

drawing-nr.:	DAB-L2G20-K-e
date of issue:	12.05.2020
name:	B. Schmidt
revision status:	001
revision date:	23.09.2020