

data sheet: K2R20S

Kroepelin GmbH
Gartenstraße 50
D-36381 Schlüchtern

Tel.: 06661 86 0
Fax: 06661 86 39
Mail: sales@kroepelin.com
Web: www.kroepelin.com

Kroepelin
Längenmesstechnik

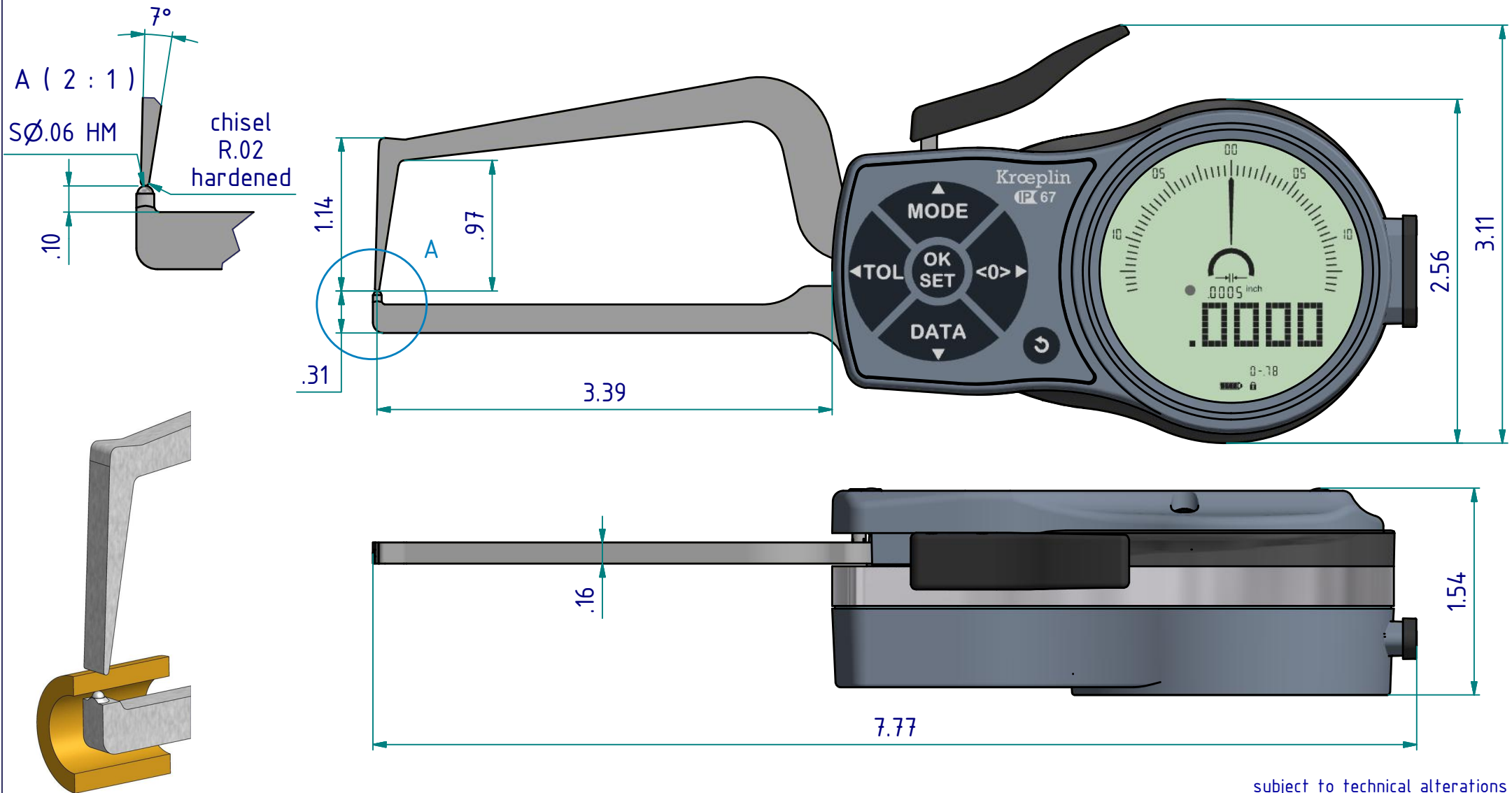

subject to technical alterations

type: K
range: 0 - .79 INCH
range of indication: 0 - .8070 INCH
digital step: .0005 INCH
scale interval: -
measuring force: 1,1 - 1,6 N
weight: 290 g

acceptable deviations
VDI/VDE/DGQ 2618 Bl. 12.1/13.1)
max. permissible errors "G": .0015 INCH
repeatability "r": .0005 INCH
reference temperature: 20° C
operation temperature: 10° C - 30° C
storage temperature: -10° C - 50° C

scale: 1:1
drawing-nr.: DAB-K2R20S-K-i
date of issue: 06.05.2020
name: B. Schmidt
revision status:
revision date:

interface as accessories available:

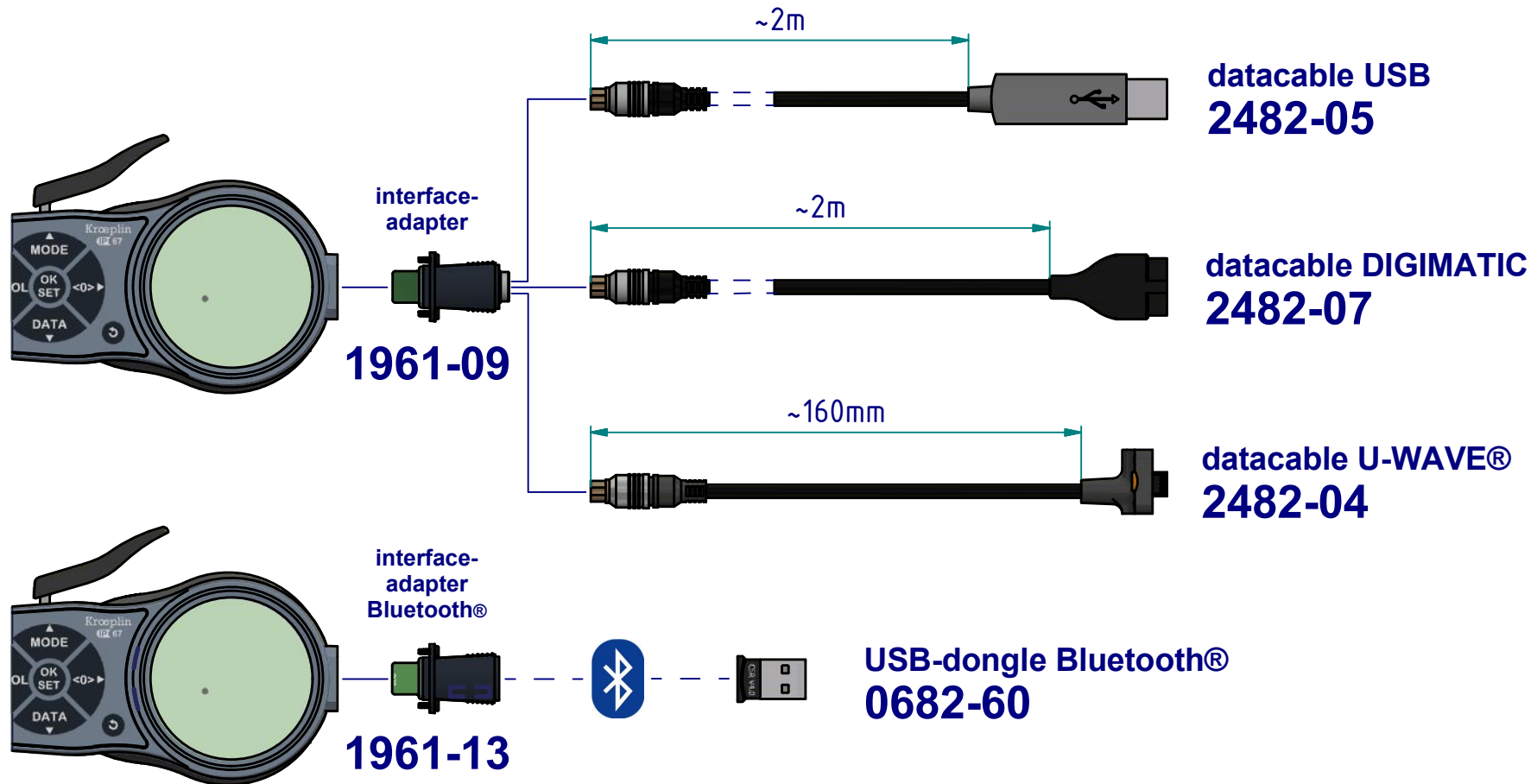

subject to technical alterations

drawing-nr.:	DAB-K2R20S-K-i
date of issue:	06.05.2020
name:	B. Schmidt
revision status:	
revision date:	